

Batería Ciclo Profundo 12V 20Ah

● Especificaciones

Voltaje Nominal		12V
Capacidad (10 Horas descarga)		20 Ah
Dimensiones	Altura Total	167 mm
	Altura	167 mm
	Largo	181 mm
	Ancho	77 mm
Peso Aprox.		5.5 Kg +/- 3%

● Dimensiones Externas (mm)

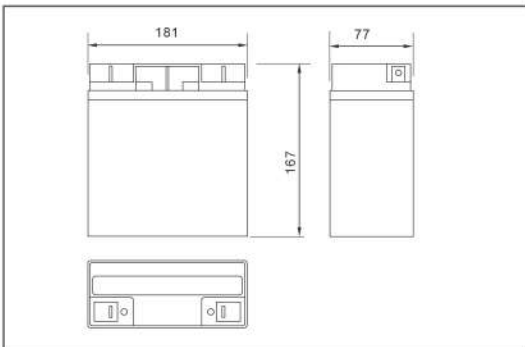

● Tipo de Terminal (mm)

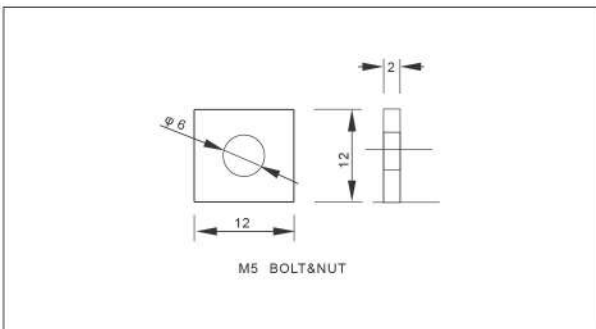

● Construcción

Componente	Placa Positiva	Placa Negativa	Contenedor	Cubierta	Separador	Electrólito	Válvula de Seguridad	Terminal
Materia Prima	Dióxido de Plomo	Plomo	ABS	ABS	Fibra de Vidrio	Ácido sulfúrico	Caucho	Cobre

● Características de descarga de corriente constante : A (25 °C, 77 °F)

FV / Time	5 min	10 min	15 min	30 min	60 min	2 h	3 h	4 h	5 h	10 h	20 h
9.60V	76.4	48.4	37.8	21.3	13.1	7.17	4.96	4.10	3.49	1.89	1.02
9.90V	74.1	46.9	36.9	20.9	12.9	7.12	4.93	4.08	3.47	1.89	1.01
10.2V	71.1	45.0	35.9	20.2	12.6	7.06	4.89	4.05	3.44	1.88	1.01
10.5V	68.0	43.1	34.3	19.7	12.3	6.95	4.86	4.02	3.42	1.87	1.00
10.8V	64.2	40.7	32.5	19.0	11.9	6.78	4.71	3.90	3.32	1.83	0.98

● Características de descarga de potencia constante : W (25 °C, 77 °F)

FV / Time	5 min	10 min	15 min	30 min	60 min	2 h	3 h	4 h	5 h	10 h	20 h
9.60V	853	546	431	244	152	83.8	58.9	48.8	41.7	22.7	12.2
9.90V	827	530	421	239	149	83.3	58.5	48.5	41.4	22.6	12.1
10.2V	793	508	405	232	146	82.6	58.1	48.2	41.1	22.5	12.1
10.5V	759	486	391	226	143	81.4	57.7	47.9	40.8	22.4	12.0
10.8V	716	459	371	218	138	79.3	56.0	46.4	39.6	21.9	11.8

*Nota: Los datos de características anteriores pueden obtenerse dentro de tres ciclos de carga o descarga.



● Características

Capacidad (25 °C)	20 HR (10.5 V)	20 Ah
	10 HR (10.5 V)	18.5 Ah
	1 HR (9.6 V)	12 Ah
Tipo de Terminal		T3/T12
Resistencia Interna Carga Completa (25 °C)		Aprox. 12 m Ω
Capacidad afectada por la temperatura (10 HR)	40 °C	102%
	25 °C	100%
	0 °C	85%
	- 15 °C	65%
Auto descarga (25°C)	3 Meses	Capacidad Restante : 91%
	6 Meses	Capacidad Restante : 82%
	12 Meses	Capacidad Restante : 65%
Temperatura Nominal de Funcionamiento		25°C ± 3 °C (77 °F ± 5°F)
Rango de Temperatura de Funcionamiento	Descarga	-15 °C ~ -50 °C (5 °F ~ -122 °F)
	Carga	-10 °C ~ -50 °C (14°F ~ -122 °F)
	Almacenamiento	-20 °C ~ -50 °C (-4 °F ~ -122 °F)
Tensión de Carga de Mantenimiento (25 °C)		13.50 to 13.80V Compensación de Temperatura : -18 mV/°C
Voltaje de carga cíclico (25 °C)		14.50 to 15.00 V Compensación de Temperatura : -30 mV/°C
Corriente de Carga Máxima		6 A
Corriente de Descarga Máxima		300 A (5 sec.)
Vida Flotante Diseñada(20°C)		5 años

● Características de descarga (25°C)

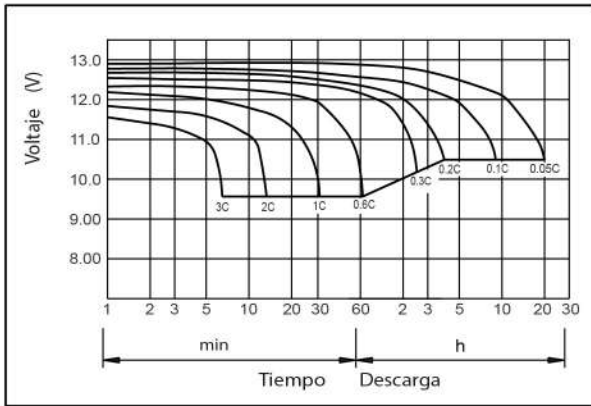

● Características de Carga (25°C)

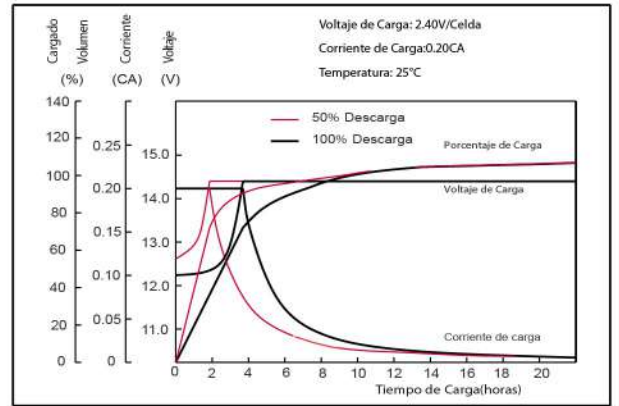

● Efectos de temperatura en la capacidad

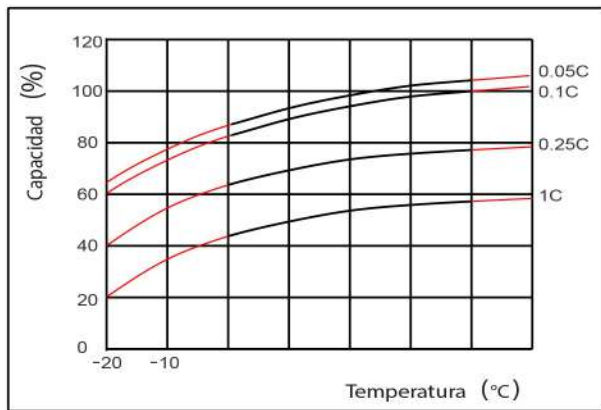

● Características de autodescarga

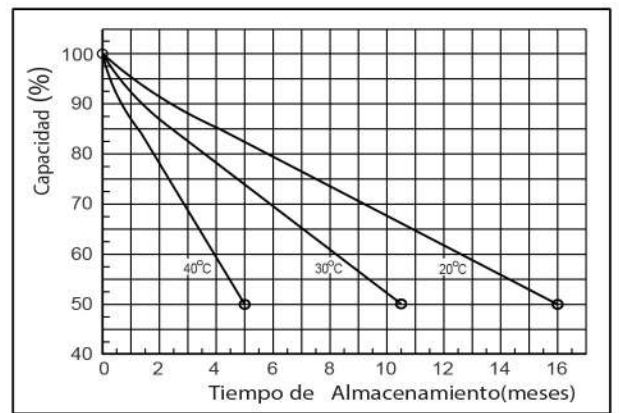

● Vida flotante en la temperatura

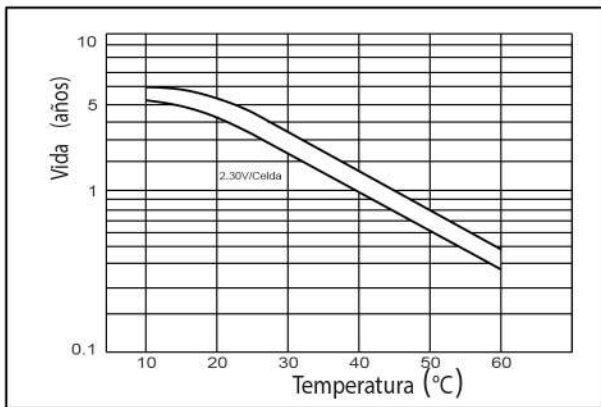

● Ciclo de vida en D.O.D (25°C)

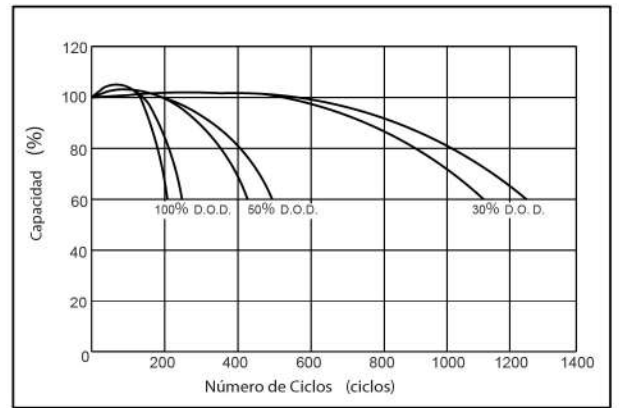

● La relación para OCV y Capacidad (25°C)

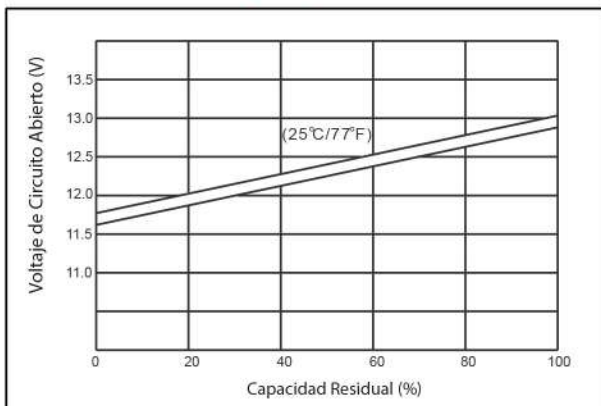

● La relación de voltaje de carga y temperatura

